

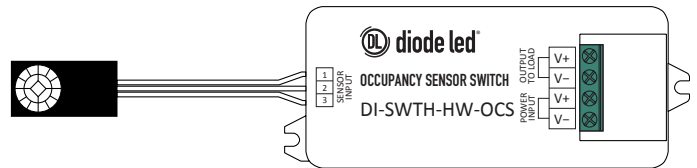

12VDC

24VDC

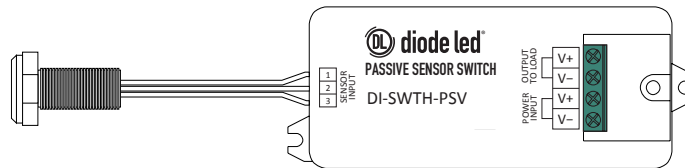
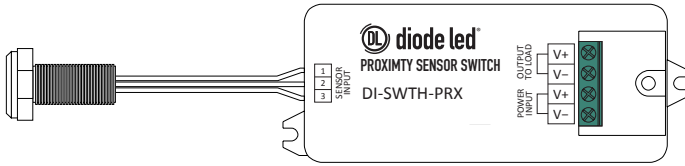

ITEM #	NAME
DI-SWTH-PRX	Proximity Sensor Switch
DI-SWTH-PSV	Passive Sensor Switch
DI-SWTH-HW-OCS	Occupancy Sensor Switch

## OVERVIEW

Diode LED's Sensor Switches allow you to control your lighting within various installation applications. From drawers to doors, these Sensors allow the use of your LED Tape Light in different ways.

Our Proximity, Passive, & Occupancy Sensor Switches help to control any on/off installation utilizing our single color, 12V or 24V products.

## FEATURES & BENEFITS

- For small-scale LED lighting installations
- Affordable and cost effective
- Easy to install
- Perfect for drawer, cabinet, or area specific lighting
- 3-Year warranty

## APPROVED LED LUMINAIRES

Diode LED Sensor Switches are compatible with all Diode LED 12V and 24VDC single color constant voltage tape lights and fixtures.

Item #	
Project	

## SPECIFICATIONS

### PROXIMITY SENSOR SWITCH

ITEM # - DI-SWTH-PRX

The Proximity Sensor Switch is commonly used for drawer, or cabinet installations. The Proximity Sensor will activate the attached LED's when the drawer, or door is opened, and deactivate them when the drawer, or door is closed. (Refer to Installation Guide for more details)

- A. Proximity Sensor Switch
- B. Proximity Sensor

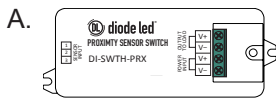

- Input from Driver: 12-24VDC Constant Voltage
- Output to Load: 12-24VDC Constant Voltage
- Max Load: 1CH x 5A, 1CH x 60W (12V), 1CH x 100W (24V)
- Sensor Range: < 2.3 inches

### PASSIVE SENSOR SWITCH

ITEM # - DI-SWTH-PSV

The Passive Sensor Switch is designed to activate the attached LED's when an object passes fully through the sensor's range. You can simply wave your hand in front of the sensor for a touch-free activation. (Refer to Installation Guide for more details)

- A. Passive Sensor Switch
- B. Passive Sensor

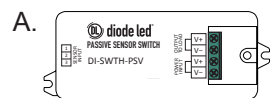

- Input from Driver: 12-24VDC Constant Voltage
- Output to Load: 12-24VDC Constant Voltage
- Max Load: 1CH x 5A, 1CH x 60W (12V), 1CH x 100W (24V)
- Sensor Range: < 2.3 inches

### OCCUPANCY SENSOR SWITCH

ITEM # - DI-SWTH-HW-OCS

The Occupancy Sensor Switch is used for any installation that requires LED's to be activated whenever someone or something is within the sensor's range. The sensor is activated by the movement of objects within range. (Refer to Installation Guide for more details)

- A. Occupancy Sensor Switch
- B. Occupancy Sensor

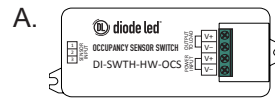

- Input from Driver: 12-24VDC Constant Voltage
- Output to Load: 12-24VDC Constant Voltage
- Max Load: 1CH x 5A, 1CH x 60W (12V), 1CH x 100W (24V)
- Sensor Range: 9.5 feet

## ENVIRONMENTAL REQUIREMENTS

- Indoor use only.
- Ambient Operating Temperature: 32°F to 104°F (0°C to 40°C)
- Humidity: 8 ~ 90% relative humidity, non-condensing.

# LED SENSOR SWITCH

SPECIFICATION SHEET

## SYSTEM DIAGRAM

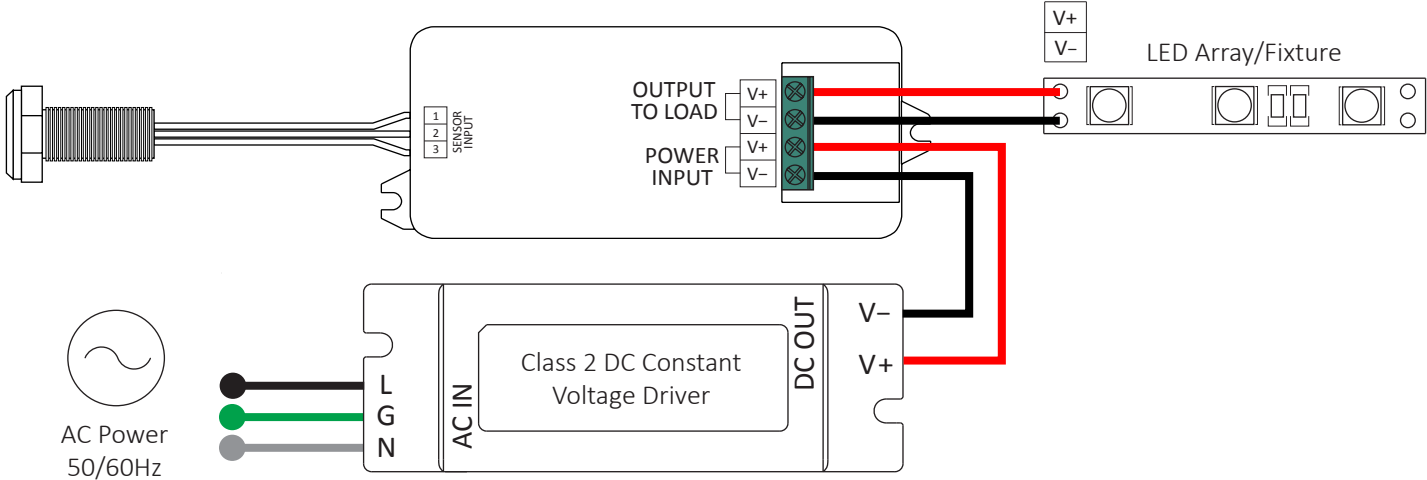

## MECHANICAL DIAGRAMS

### PROXIMITY/PASSIVE SENSOR SWITCH

TOP VIEW

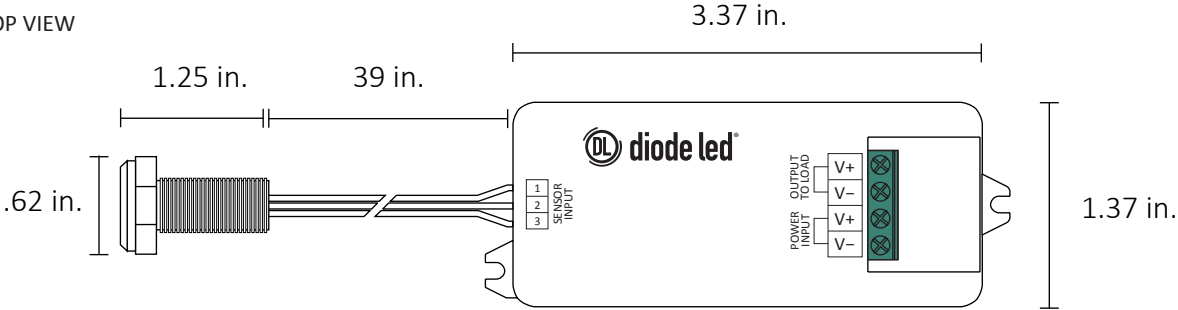

SIDE VIEW



### OCCUPANCY SENSOR SWITCH

TOP VIEW

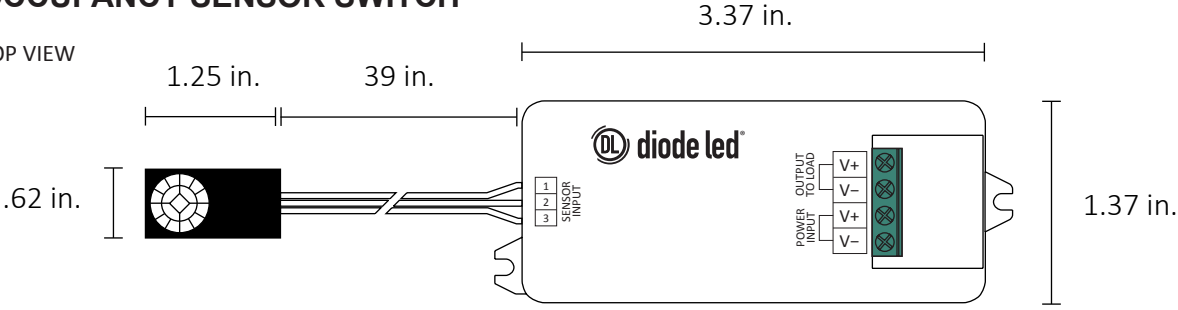

SIDE VIEW

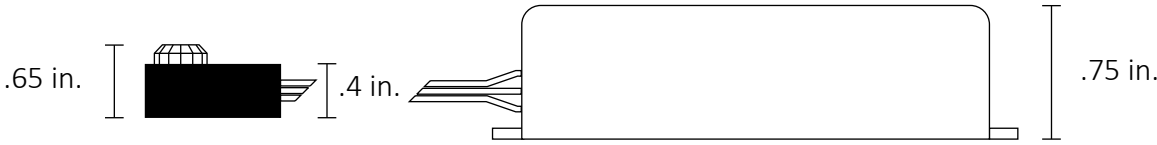

## ADDITIONAL RESOURCES

- PROXIMITY SENSOR SWITCH Installation Guide
- PASSIVE SENSOR SWITCH Installation Guide
- OCCUPANCY SENSOR SWITCH Installation Guide

## SAFETY / WARNINGS / DISCLOSURES

1. Install in accordance with national and local electrical code regulations.
2. This product is intended to be installed and serviced by a qualified, licensed electrician.
3. DO NOT connect directly to high voltage power. Install with a compatible Class 2 constant voltage LED driver (power supply).
4. Only install compatible 12V and 24VDC constant voltage luminaires.
5. This product is rated for indoor installation and is not protected against moisture.
6. Do not modify product beyond instructions or warranty will be void.

## WARRANTY

### Limited Warranty

This product has a 5 year limited warranty from the date of shipment. This warranty does not include the additional accessories referenced in this specification sheet. Complete warranty details for fixtures and additional accessories are available at [www.DiodeLED.com](http://www.DiodeLED.com) under the 'Tools & Resources' tab. For warranty related questions please contact product support.

### Consumer's Acknowledgment

Diode LED stands behind its products when they are used properly and according to our specifications. By purchasing our products, the purchaser agrees and acknowledges that lighting design, configuration and installation is a complex process, wherein seemingly minor factors or changes in layout and infield adjustments can have a significant impact on an entire system. Choosing the correct components is essential. Diode LED is able to work with the original purchaser to make an appropriate product selection to the extent of the limited information that the customer can provide, but it is virtually impossible for Diode LED to design a system that foresees every unknown factor. For this reason, this Warranty does not cover problems caused by improper design, configuration or installation issues. Any statement from a Diode LED employee or agent regarding a customer's bill of goods and/or purchase order is NOT an acknowledgment that the products purchased are designed and configured correctly. The purchaser agrees and acknowledges that it is the customer's responsibility to adhere strictly to all information contained in the Product Specification Sheets.

There is often more than one way to design, configure and layout an LED lighting application properly to achieve the same lighting effect. Diode LED strongly recommends that licensed professionals be used in the design and installation of lighting systems that include Diode LED products. The specifications include important information that a designer and installer should carefully review and strictly follow. Qualified designers and certified and/or licensed installers, with access to the final installation environment, customer goals, and Diode LED product specifications can make the requisite decisions appropriate for a successful finished lighting application.

